

SONY

Personal Audio System **SRS-X33**

Pairing and connecting with a BLUETOOTH device

The speaker can be paired with up to eight BLUETOOTH devices.

When pairing with two or more BLUETOOTH devices, perform the following pairing procedure for each device.

Before operating the speaker, be sure to do the following:

- Place the BLUETOOTH device within 1 m (3 ft) of the speaker.
- Connect the speaker to the AC outlet or charge the battery sufficiently.
- Stop playback on a BLUETOOTH device to avoid sudden loud sound output from the speaker.
- Prepare the operating instructions supplied with the BLUETOOTH device for reference.

1. Turn on the speaker.

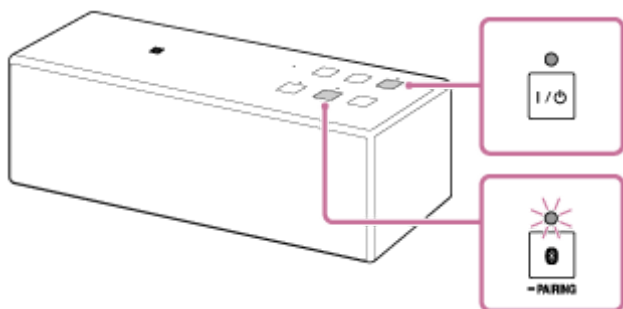

The  (power) indicator lights up in green.

The  (BLUETOOTH) indicator begins to flash in white.



- When you turn on the speaker for the first time after purchase, it enters the pairing mode automatically. Proceed to step 3.
- The speaker tries to make BLUETOOTH connection with the last connected BLUETOOTH device. If the device is nearby and its BLUETOOTH function is on, the BLUETOOTH connection is established automatically and the 

(BLUETOOTH) indicator stays lit. When you want to connect another BLUETOOTH device, terminate the current BLUETOOTH connection by operating the currently connected BLUETOOTH device.

2. Press and hold the  (BLUETOOTH)  PAIRING button until beeps are heard and the  (BLUETOOTH) indicator begins to flash quickly in white. The speaker enters pairing mode.

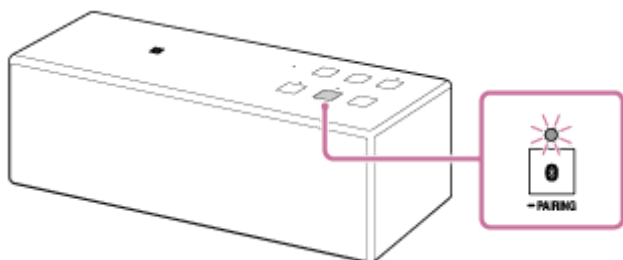

3. Perform the pairing procedure on the BLUETOOTH device to detect the speaker.

When a list of detected devices appears on the display of the BLUETOOTH device, select "SRS-X33."

If a passkey* is required on the display of the BLUETOOTH device, enter "0000."

* A passkey may be called "Passcode", "PIN code", "PIN number" or "Password."

4. Make the BLUETOOTH connection from the BLUETOOTH device. When the BLUETOOTH connection is established, the  (BLUETOOTH) indicator stays lit.

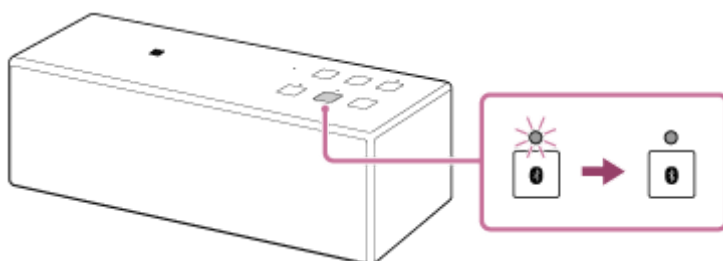

If the BLUETOOTH connection is not established, repeat from step 2.

Hint

- For details on operating a BLUETOOTH device, refer to the operating instructions supplied with the BLUETOOTH device.

Note

- The pairing mode of the speaker is released after about 5 minutes and the  (BLUETOOTH) indicator flashes slowly. However, when pairing information is not stored in the speaker, such as at the factory settings, the pairing mode is not released. If the pairing mode is released before finishing the process, repeat from step 2.
- When pairing with a BLUETOOTH device that cannot display a list of detected devices or that has no display, you may be able to pair the device by setting both the speaker and the BLUETOOTH device to pairing mode. At this time, if a passkey is set besides “0000” on the BLUETOOTH device, pairing cannot be done with the speaker.
- Once the BLUETOOTH devices are paired, there is no need to pair them again, except in the following cases:

Pairing information has been deleted after repair, etc.

The speaker is already paired with eight devices and another device is to be paired.

The speaker can be paired with up to eight devices. If a new device is paired after eight devices have already been paired, the paired device with the oldest connection time is replaced by the new one.

When the pairing information of the speaker has been deleted from the BLUETOOTH device.

When the speaker is initialized, all the pairing information is deleted.

- The speaker can be paired with multiple devices, but can only play music from one paired device at a time.
- When an audio cable is connected to the speaker’s AUDIO IN jack while the speaker and the BLUETOOTH device have been connected via BLUETOOTH connection, sound from the BLUETOOTH-connected device is not output from the speaker (the hands-free function is available). To listen to music from the BLUETOOTH device, disconnect the audio cable from the speaker’s AUDIO IN jack.